

Panasonic®

Quick Guide

SIP Cordless Phone

Model No. **KX-TGP500** **B04**

Model No. **KX-TGP500** **T04**

DECT
6.0

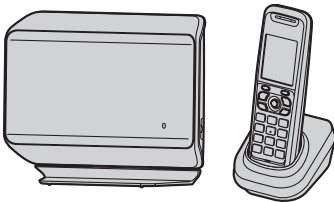

Model shown is KX-TGP500.

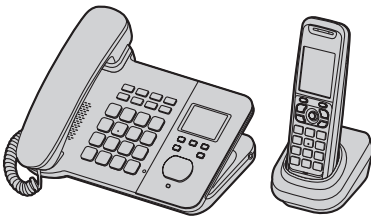

Model shown is KX-TGP550.

Contents/Contenu/Contenido	Page/Page/Página
English instructions	1 - 26
Instructions en français	(1) - (24)
Instrucciones en español	<1> - <21>

Thank you for purchasing a Panasonic product.

Charge the batteries for about 6 hours before initial use.

Please read this guide before using the unit and save it for future reference.

Table of Contents

Introduction

About this guide.	3
Accessory information.	3

Important Information

For your safety	4
Important safety instructions	5
For best performance	5
Security caution.	6
Other information.	6
Emergency calls	7
Open Source Software Notice.	7

Controls

Handset.	8
Base unit	9
STATUS indicator on the base unit	11

Basic Operations

Making calls using the handset.	13
Making calls using the base unit (KX-TGP550 only).	13
Answering calls using the handset	14
Answering calls using the base unit (KX-TGP550 only).	15
Hold.	15
Transferring calls	15

Setting Up

Setting up the base unit.	17
Setting up the handset	19
Note when setting up.	19
Setting network	20

Useful Information

FCC and other information	22
Industry Canada Notices and other information.	24

About this guide

This guide explains how to use the basic features of KX-TGP500/KX-TGP550. For further information on operations and customizing your phone, please read the User Guide on the Panasonic Web site at:

<http://www.panasonic.com/sip> (for users in the United States)

<http://panasonic.net/pcc/support/sipphone> (for users in Canada)

Contact your administrator for further information.

Accessory information

Note:

- See page 17 for setting up the unit.

Supplied accessories

No.	Accessory item/Order number	Quantity	
		KX-TGP500	KX-TGP550
①	AC adaptor/PQLV219 ou PQLV219 (03)	2	2
②	Ethernet cable/PNJA1019Z	1	1
③	Base unit stand ^{*1} /PNKL1003Z1	1	–
④	Corded handset/PNLXP1007Z	–	1
⑤	Corded handset cord/PSJA1115Z	–	1
⑥	Rechargeable batteries/HHR-4DPA (Part No. HHR-65AAABU or N4DHYYY00002)	2	2
⑦	Handset cover ^{*2} /PNYNTGA641TR	1	1
⑧	Belt clip/PNKE1029Z1	1	1
⑨	Charger/PNWETGP500B	1	1
⑩	Index sticker ^{*3} /PNQT1735Z	–	1

*1 The base unit stand comes attached to the base unit.

*2 The handset cover comes attached to the handset.

*3 Write down the names of 6 users and attach to the base unit (page 10).

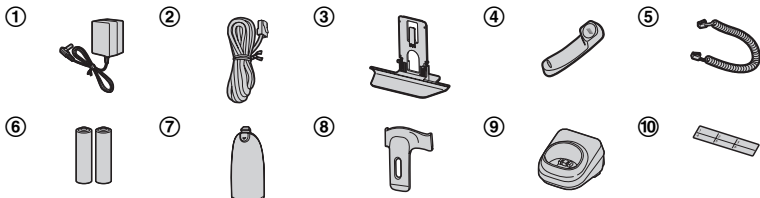

For your safety

To prevent severe injury and loss of life/property, read this section carefully before using the product to ensure proper and safe operation of your product.

WARNING

Power connection

- Use only the power source marked on the product.
- Do not overload power outlets and extension cords. This can result in the risk of fire or electric shock.
- Completely insert the AC adaptor/power plug into the power outlet. Failure to do so may cause electric shock and/or excessive heat resulting in a fire.
- Regularly remove any dust, etc. from the AC adaptor/power plug by pulling it from the power outlet, then wiping with a dry cloth. Accumulated dust may cause an insulation defect from moisture, etc. resulting in a fire.
- Unplug the product from power outlets if it emits smoke, an abnormal smell, or makes an unusual noise. These conditions can cause fire or electric shock. Confirm that smoke has stopped emitting and contact your phone system dealer.
- Unplug from power outlets and never touch the inside of the product if its casing has been broken open.
- Never touch the plug with wet hands. Danger of electric shock exists.

Installation

- To prevent the risk of fire or electrical shock, do not expose the product to rain or any type of moisture.
- Do not place or use this product near automatically controlled devices such as automatic doors and fire alarms. Radio waves emitted from this product may cause such devices to malfunction resulting in an accident.
- Do not allow the AC adaptor or Ethernet cable to be excessively pulled, bent or placed under heavy objects.

Operating safeguards

- Unplug the product from power outlets before cleaning. Do not use liquid or aerosol cleaners.
- Do not disassemble the product.
- Do not spill liquids (detergents, cleansers, etc.) onto the Ethernet cable plug, or allow it to become wet at all. This may cause a fire. If the Ethernet cable plug becomes wet, immediately pull it from the LAN (Local Area Network) wall jack, and do not use.
- KX-TGP550 only: Do not excessively pull the corded handset cord from the base unit. This may cause the base unit to fall, resulting in injury.

Medical

- Consult the manufacturer of any personal medical devices, such as pacemakers or hearing aids, to determine if they are adequately shielded from external RF (radio frequency) energy. (The product operates in the frequency range of 1.92 GHz to 1.93 GHz, and the RF transmission power is 115 mW (max.).)
- Do not use the product in health care facilities if any regulations posted in the area instruct you not to do so. Hospitals or health care facilities may be using equipment that could be sensitive to external RF energy.

CAUTION

Installation and relocation

- Never install LAN (Local Area Network) during an electrical storm.
- Never install Ethernet cable jacks in wet locations unless the jack is specifically designed for wet locations.
- Never touch uninsulated LAN (Local Area Network) or terminals unless the LAN (Local Area Network) has been disconnected at the network interface.
- Use caution when installing or modifying LAN (Local Area Network).
- The AC adaptor is used as the main disconnect device. Ensure that the AC outlet is installed near the product and is easily accessible.
- This product is unable to make calls when there is a power failure.

Battery

- We recommend using the batteries noted on page 3. **USE ONLY rechargeable Ni-MH batteries AAA (R03) size.**
- Do not mix old and new batteries.
- Do not open or mutilate the batteries. Released electrolyte from the batteries is corrosive and may cause burns or injury to the eyes or skin. The electrolyte is toxic and may be harmful if swallowed.
- Exercise care when handling the batteries. Do not allow conductive materials such as rings, bracelets, or keys to touch the batteries, otherwise a short circuit may cause the batteries and/or the conductive material to overheat and cause burns.
- Charge the batteries provided with or identified for use with this product only, in accordance with the instructions and limitations specified in this manual.
- Only use a compatible charger to charge the batteries. Do not tamper with the charger. Failure to follow these instructions may cause the batteries to swell or explode.

Attention:



A nickel metal hydride battery that is recyclable powers the product you have purchased. Please call 1-800-8-BATTERY (1-800-822-8837) for information on how to recycle this battery.

Important safety instructions

When using your product, basic safety precautions should always be followed to reduce the risk of fire, electric shock, and injury to persons, including the following:

1. Do not use this product near water for example, near a bathtub, washbowl, kitchen sink, or laundry tub, in a wet basement or near a swimming pool.
2. Avoid using a telephone (other than a cordless type) during an electrical storm. There may be a remote risk of electric shock from lightning.
3. Do not use the telephone to report a gas leak in the vicinity of the leak.
4. Use only the power cord and batteries indicated in this manual. Do not dispose of batteries in a fire. They may explode. Check with local codes for possible special disposal instructions.

SAVE THESE INSTRUCTIONS

For best performance

Base unit location/avoiding noise

The base unit and other compatible Panasonic units use radio waves to communicate with each other.

- For maximum coverage and noise-free communications, place your base unit:
 - at a convenient, high, and central location with no obstructions between the cordless handset and base unit in an indoor environment.
 - away from electronic appliances such as TVs, radios, personal computers, wireless devices, or other phones.
 - facing away from radio frequency transmitters, such as external antennas of mobile phone cell stations. (Avoid putting the base unit on a bay window or near a window.)
- Coverage and voice quality depends on the local environmental conditions.
- If the reception for a base unit location is not satisfactory, move the base unit to another location for better reception.

Important Information

Environment

- Keep the product away from electrical noise generating devices, such as fluorescent lamps and motors.
- The product should be kept free from excessive smoke, dust, high temperature, and vibration.
- The product should not be exposed to direct sunlight.
- Do not place heavy objects on top of the product.
- When you leave the product unused for a long period of time, unplug the product from the power outlet.
- The product should be kept away from heat sources such as heaters, kitchen stoves, etc. It should not be placed in rooms where the temperature is less than 0 °C (32 °F) or greater than 40 °C (104 °F). Damp basements should also be avoided.
- The maximum calling distance may be shortened when the product is used in the following places: Near obstacles such as hills, tunnels, underground, near metal objects such as wire fences, etc.
- Operating the product near electrical appliances may cause interference. Move away from the electrical appliances.

Routine care

- **Wipe the outer surface of the product with a soft moist cloth.**
- Do not use benzine, thinner, or any abrasive powder.

Security caution

When using this product, take appropriate measures to avoid the following security breaches.

- Leaks of private information via this product
- Illegal use of this product by a third party
- Interference or suspension of the use of this product by a third party

Take the following measures to avoid security breaches:

- To prevent illegal access, keep the base unit software updated (if you do not have the latest version of software, this can lead to blocked access or information leaks).

Refer to the User Guide on the Panasonic Web site. See page 3 for Panasonic URL.

- You are responsible for the security settings, such as the password for the Web user interface, to access this product. This information should not be made available to any third parties outside the user group. To prevent unauthorized access to this product, we recommend that you regularly change the password.
- Place this product where it is unlikely to be stolen.
- During an Internet call, outside interference may occur resulting in improper call transmission and/or unit function.

Other information

CAUTION: Risk of explosion if battery is replaced by an incorrect type. Dispose of used batteries according to the instructions.

Notice for product disposal, transfer, or return

- This product can store your private/confidential information. To protect your privacy/confidentiality, we recommend that you erase information such as phonebook or caller list entries, or the password for the Web user interface from the memory before you dispose of, transfer, or return the product. Contact your administrator about resetting the password for the Web user interface.

Notice

- This product is designed for use in the United States of America and Canada. Sale or use of this product in other countries may violate local laws.
- Cet appareil est conçu pour être utilisé aux États-Unis d'Amérique et au Canada. La vente ou l'emploi de cet appareil dans certains autres pays peut constituer une infraction à la législation locale.
- Este producto está diseñado para usarse en los Estados Unidos de América. La venta o el empleo de este producto en ciertos países puede constituir violación de la legislación local.
- 本產品專為美國使用而設。若在其他國家銷售或使用，可能會違反當地法例。
- この製品は、日本国外での使用を目的として設計されており、日本国内での使用は法律違反となります。従って、当社では日本国内においては原則として修理などのサービスは致しかねます。

Emergency calls

All lines including unassigned lines are available for emergency calls if the phone numbers are configured in the Web user interface. Availability depends on your phone system. Contact your administrator for further information.

Open Source Software Notice

Parts of this product use open source software. For details about the open source software, see the User Guide.

Handset

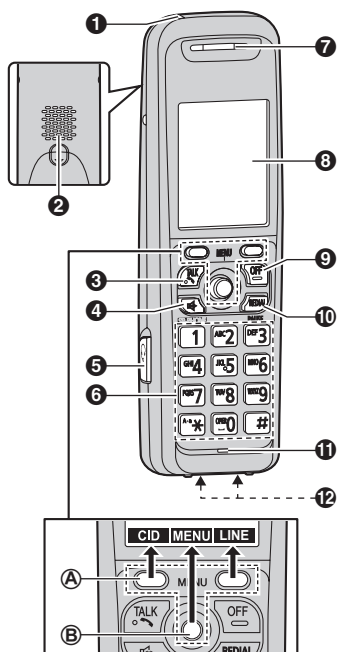

- 1** Charge indicator
Ringer indicator
Message indicator
- 2** Speaker
- 3** [**TALK**]
• To make calls
- 4** [**SP-PHONE**: Speakerphone]
• To talk hands-free
- 5** Headset jack
- 6** Dial keypad
- 7** Receiver
- 8** Display
- 9** [**OFF**]
• To stop operation
- 10** [**REDIAL**] [**PAUSE**]
- 11** Microphone

12 Charge contacts

■ Control type

Ⓐ Soft keys

The handset features 2 soft keys and a joystick. By pressing a soft key, or by pressing the center of the joystick, you can select the feature shown directly above it on the display.

Ⓑ Joystick

By pushing the joystick (**▲**), **▼**), **◀**), or **▶**) repeatedly, you can:

- scroll through (up, down, left, or right) various lists or items
- adjust the receiver or speaker volume (up or down) while talking

Temporarily switching the handset display mode

You can select to display either a single item or multiple items on one screen at a time for the phonebook list, caller list, and redial list.

You can temporarily switch the handset display mode as follows by pressing the right soft key shown when viewing the lists with:

- [**MULTI**]: Multiple items are shown on one screen at a time.
- [**SINGLE**]: An item is shown on one screen at a time. You can confirm the detailed information.

Base unit

KX-TGP500

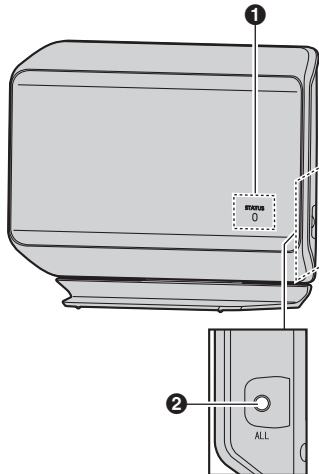

- 1 STATUS indicator**
 - Indicates the status of the unit and network.
- 2 Handset locator button [ALL]**
 - Allows you to page all handsets.

KX-TGP550

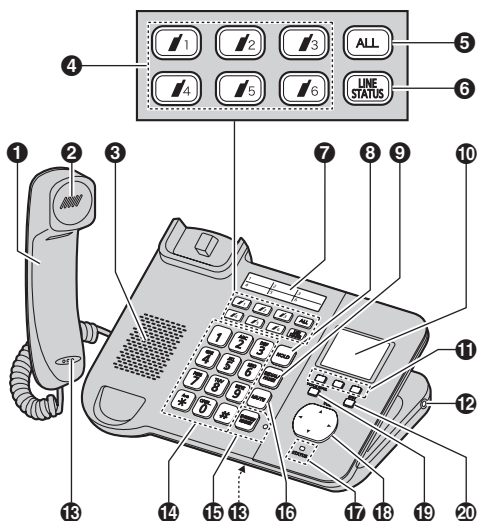

- 1** Corded handset
- 2** Receiver
- 3** Speaker
- 4** Handset paging buttons ([**1**] – [**6**])
Handset status indicators
 - Allow you to page each handset. Also they show the status of each handset.
- 5** Handset paging button [**ALL**]
 - Allows you to page all handsets.
- 6** [**LINE STATUS**]
 - Tells you the status of each line on the display.
- 7** Index sticker
 - You can write down the names of 6 users on the supplied index sticker and attach it to the base unit.
- 8** [**HOLD**]
- 9** [**REDIAL**] [**PAUSE**]
- 10** Display
- 11** Soft keys
- 12** Headset jack
- 13** Microphone
- 14** Dial keypad
- 15** [**SP-PHONE**] [**HEADSET**] SP-PHONE indicator
- 16** [**MUTE**]
- 17** **STATUS** indicator
 - Indicates the status of the unit and network.
- 18** Navigator key ([**▲**]/[**▼**]/[**◀**]/[**▶**])
VOL. (Volume: [**▲**]/[**▼**])
- 19** [**VOICE MAIL**]^{*1} VOICE MAIL indicator
- 20** [**EXIT**]
 - To stop operation

*1 Your phone system needs to support voice mail. Contact your administrator for further information.

Navigator key/volume key

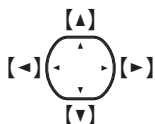

■ Scrolling through lists or items

By pressing this key ([▲], [▼], [◀], or [▶]) repeatedly, you can scroll through (up, down, left, or right) various lists or items.

■ Adjusting the volume

By pressing this key ([▲] or [▼]) repeatedly, you can adjust the receiver or speaker volume (up or down) while talking.

■ Moving the cursor

By pressing this key ([▲], [▼], [◀], or [▶]) repeatedly, you can move the cursor to edit a number or name.

Soft keys

The base unit features 3 soft keys. By pressing a soft key, you can select the feature shown directly above it on the display.

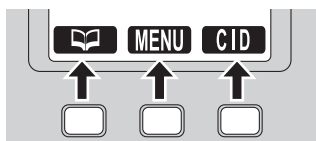

STATUS indicator on the base unit

During the startup process you may notice that the STATUS indicator on the base unit is flashing. This indicates that the base unit is booting up with your phone system. You may find the following flash patterns helpful:

Status		Meaning
Color	Light pattern	
Green	On	<ul style="list-style-type: none"> The base unit is connected to the Internet. The startup process is complete and you may now make and receive Internet calls.
	Flashing	<ul style="list-style-type: none"> The base unit is downloading data. Do not disconnect the Ethernet cable or AC adaptor from the base unit until the STATUS indicator stops flashing and lights in steady green.

Controls

Status		Meaning
Color	Light pattern	
Red	On	<ul style="list-style-type: none"> When the base unit is turned on, the STATUS indicator lights in red for about 10 seconds.
	Flashing	<ul style="list-style-type: none"> The base unit is registering a handset.
	Flashing rapidly	<ul style="list-style-type: none"> The base unit is paging handsets. (KX-TGP500 only)
Amber	On	<ul style="list-style-type: none"> The base unit's IP address may conflict with the IP addresses of other devices on your local network. Contact your administrator for further information.
	Flashing	<ul style="list-style-type: none"> The base unit is obtaining an IP address or is obtaining configurations. Please wait. The base unit is registering with your phone system. Please wait. If the STATUS indicator continues flashing, check the following: <ul style="list-style-type: none"> Network settings may not be correct. Contact your administrator. Many installation issues can be resolved by resetting all the equipment. First, shut down your modem, router, hub, base unit, and computer. Then turn the devices back on one at a time in this order: modem, router, hub, base unit, computer. If you cannot access Internet Web pages using your computer, check to see if your phone system is having connection issues in your area. For more troubleshooting help, contact your administrator.
	Flashing rapidly	<ul style="list-style-type: none"> Unplug the base unit's AC adaptor to reset the unit, then reconnect the AC adaptor. If the STATUS indicator is still flashing rapidly, there may be a problem with the base unit hardware. Contact your phone system dealer.
Off	—	<ul style="list-style-type: none"> The base unit power is off. The Ethernet cable is not connected properly. Connect it. Your network devices (hub, router, etc.) are turned off. Check the LEDs for the link status of the devices. The base unit power is booting up.

Making calls using the handset

- Lift the handset and dial the phone number.
 - To correct a digit, press **[CLEAR]**.
- Press **[CALL]** or **[↶]**.
 - The unit selects the default line configured by your administrator.
 - You can also select the line manually as follows:
[LINE] → **[▼]/[▲]**: Select the desired line. → **[CALL]**
- When you finish talking, press **[OFF]** or place the handset on the charger.

Note:

- For further details, please read the User Guide on the Panasonic Web site. See page 3 for Panasonic URL.

Using the speakerphone

- Dial the phone number and press **[☎]**.
 - The unit selects the default line configured by your administrator.
 - You can also select the line manually as follows:
[LINE] → **[▼]/[▲]**: Select the desired line. → **[☎]**
 - Speak alternately with the other party.
- When you finish talking, press **[OFF]**.

Note:

- For best performance, use the speakerphone in a quiet environment.
- To switch back to the receiver, press **[↶]**.

Adjusting the receiver or speaker volume

Push the joystick up or down repeatedly while talking.

Making a call using the redial list

The last 10 phone numbers dialed are stored in the redial list (each 32 digits max.).

- [REDIAL]**
- [▼]/[▲]**: Select the desired phone number.
- [↶]/[☎]**
 - If **[☎]** is pressed and the other party's line is engaged, the unit automatically redials multiple times. While the handset is waiting to redial, the ringer indicator flashes. To cancel, press **[OFF]**.

Making calls using the base unit (KX-TGP550 only)

- Dial the phone number.
 - To correct a digit, press **[CLEAR]**.
- Lift the corded handset.
 - The unit selects the default line configured by your administrator.
 - You can also select the line manually as follows:
[LINE] → **[▼]/[▲]**: Select the desired line. → Lift the corded handset.
- When you finish talking, place the corded handset on the cradle.

Basic Operations

Note:

- You can also dial the phone number after lifting the corded handset.
- For further details, please read the User Guide on the Panasonic Web site. See page 3 for Panasonic URL.

Using the speakerphone

- 1 Dial the phone number and press **[SP-PHONE]**.
 - The unit selects the default line configured by your administrator.
 - You can also select the line manually as follows:
[LINE] → **[▼]/[▲]**: Select the desired line. → Press **[CALL]** or **[SP-PHONE]**.
- 2 When the other party answers, speak into the base unit microphone.
 - Speak alternately with the other party.
- 3 When you finish talking, press **[SP-PHONE]**.

Note:

- For best performance, use the speakerphone in a quiet environment.
- To switch to the receiver, lift the corded handset.

Adjusting the receiver or speaker volume

Press **[▲]** or **[▼]** repeatedly while talking.

Making a call using the redial list

The last 10 phone numbers dialed are stored in the redial list in each unit (each 32 digits max.).

- 1 **[REDIAL]**

- 2 **[▼]/[▲]**: Select the desired phone number.
- 3 Lift the corded handset or press **[SP-PHONE]**.
 - If **[SP-PHONE]** is pressed and the other party's line is engaged, the unit automatically redials multiple times. While the base unit is waiting to redial, the **SP-PHONE** indicator on the base unit flashes. To cancel, press **[EXIT]**.

Answering calls using the handset

When a call is being received, the ringer indicator on the handset flashes rapidly.

- 1 Lift the handset and press **[CALL]**, **[📞]**, or **[📞]** when the unit rings.
 - You can also answer the call by pressing any dial key from **[0]** to **[9]**, **[*]**, or **[#]**. (**Any key answer feature**)
- 2 When you finish talking, press **[OFF]** or place the handset on the charger.

Adjusting the handset ringer volume

- **While the handset is ringing for an incoming call:**
Push the joystick up or down repeatedly to select the desired volume.
- **Programming the volume beforehand:**
 - 1 **[MENU]** (center of joystick) → **[#][1][6][0]**
 - 2 **[▼]/[▲]**: Select the desired volume.
 - 3 **[SAVE]** → **[OFF]**

Answering calls using the base unit (KX-TGP550 only)

- 1 Lift the corded handset or press **[CALL]** or **[SP-PHONE]** when the unit rings.
- 2 When you finish talking, place the corded handset on the cradle. When the speakerphone is used, press **[SP-PHONE]**.

Adjusting the base unit ringer volume

■ While the base unit is ringing for an incoming call:

Press **[▲]** or **[▼]** repeatedly to select the desired volume.

■ Programming the volume beforehand:

- 1 **[MENU]** (middle soft key) → **[#][1][6][0]**
- 2 **[▼]/[▲]**: Select the desired volume.
- 3 **[SAVE]** → **[EXIT]**

Hold

This feature allows you to put an outside call on hold.

Handset

- 1 Press **[HOLD]** during an outside call.
- 2 To release hold, press **[HOLD]** or **[↶]**.

Base unit

Available for: KX-TGP550

- 1 Press **[HOLD]** during an outside call.
 - If you are using the corded handset, you can place it on the cradle.
- 2 To release hold, lift the corded handset, or press **[HOLD]** or **[SP-PHONE]**.

Transferring calls

Outside calls can be transferred to:

- another unit
- an outside party

Using the handset

Transferring calls to another unit

- 1 During an outside call, press **[MENU]**.
- 2 **[▼]/[▲]**: “Intercom” → **[SELECT]**
- 3 **[▼]/[▲]**: Select the desired unit. → **[CALL]**
- 4 Wait for the paged party to answer.
 - If the paged party does not answer, press **[↶]** to return to the outside call.
- 5 **[OFF]**

Transferring calls to an outside party

- 1 During an outside call, press **[MENU]**.
- 2 **[▼]/[▲]**: “Transfer” → **[SELECT]**
- 3 Dial the phone number.

Basic Operations

- To correct the number, press **[CANCEL]** to clear the number and enter again.
- 4 Wait for the paged party to answer.
 - If the paged party does not answer, press **[CANCEL]** 2 times to return to the outside call.
 - 5 **[TRANS]**

Using the base unit

Available for: KX-TGP550

Transferring calls to another unit

- 1 During an outside call, press **[∇ 1]** – **[∇ 6]** or **[ALL]**.
- 2 Wait for the paged party to answer.
 - If the paged party does not answer, press the same button as in step 1 to return to the outside call.
- 3 Place the corded handset on the cradle.

Transferring calls to an outside party

- 1 During an outside call, press **[MENU]**.
- 2 **[∇]/[\blacktriangle]: “Transfer” → **[SELECT]****
- 3 Dial the phone number.
 - To correct the number, press **[CANCEL]** to clear the number and enter again.
- 4 Wait for the paged party to answer.
 - If the paged party does not answer, press **[CANCEL]** 2 times to return to the outside call.
- 5 **[TRANS]**

Setting up the base unit

Connecting the base unit

Important:

- Use only the supplied Panasonic AC adaptor PQLV219 or PQLV219 (03).
- KX-TGP550 only: Do not connect the Ethernet cable connected to the PoE hub to the PC port of the unit. Doing so may cause severe damage to the unit.

KX-TGP500

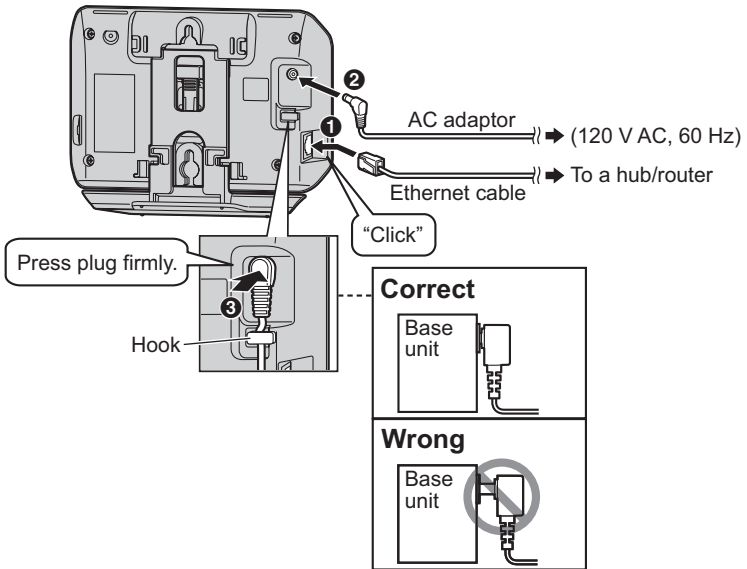

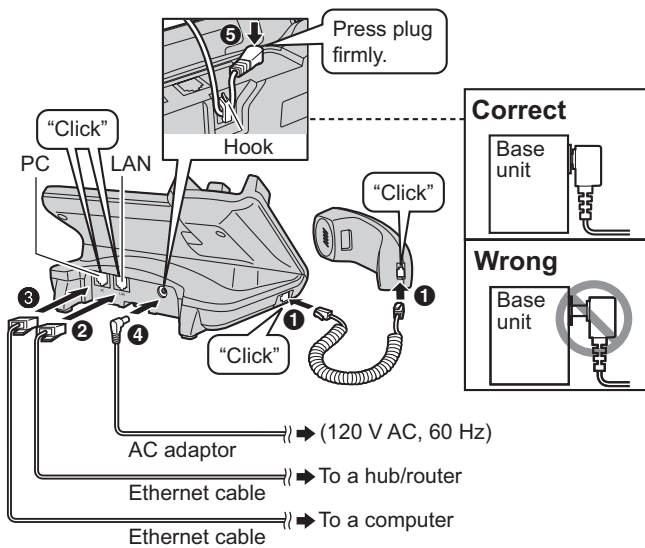

Setting up the handset

Connecting the charger

- Use only the supplied Panasonic AC adaptor PQLV219 or PQLV219 (03).

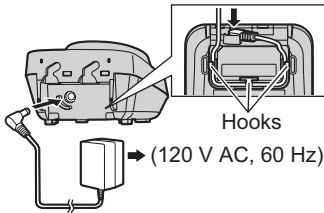

Battery installation

- USE ONLY Ni-MH batteries AAA (R03) size.
- Do NOT use Alkaline/Manganese/Ni-Cd batteries.
- Confirm correct polarities (\oplus , \ominus).

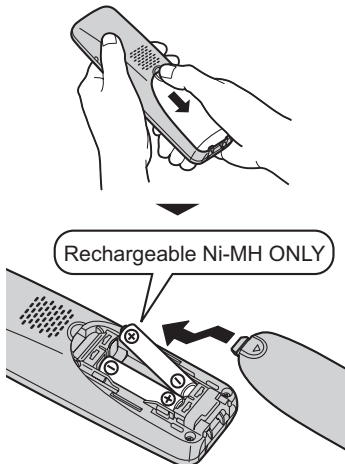

Battery charge

Charge for about 6 hours.

- When the batteries are fully charged, the charge indicator goes off.

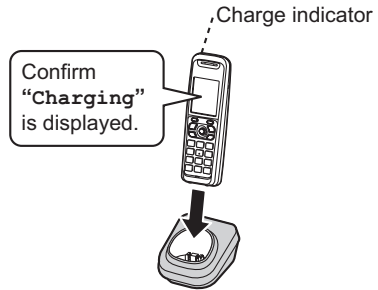

Note when setting up

Note for connections

- The AC adaptor must remain connected at all times. (It is normal for the adaptor to feel warm during use.)
- The AC adaptor should be connected to a vertically oriented or floor-mounted AC outlet. Do not connect the AC adaptor to a ceiling-mounted AC outlet, as the weight of the adaptor may cause it to become disconnected.
- The unit will not work during a power failure.

Note for battery installation





- Use the supplied rechargeable batteries. For replacement, we recommend using the Panasonic rechargeable batteries noted on page 3.
- Wipe the battery ends (\oplus , \ominus) with a dry cloth.
- Avoid touching the battery ends (\oplus , \ominus) or the unit contacts.

Setting Up

Note for battery charge

- It is normal for the handset to feel warm during charging.
- Clean the charge contacts of the handset and charger with a soft and dry cloth once a month. Clean more often if the unit is exposed to grease, dust, or high humidity.

Battery level

Icon	Battery level
	High
	Medium
	Low
	Needs charging
	Empty

Panasonic Ni-MH battery performance (supplied batteries)

Operation	Operating time
In continuous use	5 hours max.
Not in use (standby)	10 days max.

Note:

- It is normal for batteries not to reach full capacity at the initial charge. Maximum battery performance is reached after a few complete cycles of charge/discharge (use).
- Actual battery performance depends on a combination of how often the handset is in use and how often it is not in use (standby).
- Even after the handset is fully charged, the handset can be left on the charger without any ill effect on the batteries.
- The battery level may not be displayed correctly after you replace

the batteries. In this case, place the handset on the charger and let it charge for at least 6 hours.

Setting network

Important:

- We recommend configuring these settings with your administrator. You can also configure the network settings through the Web user interface. Contact your administrator for further information.

Automatic setup (default)

Turning the DHCP connection mode on

Handset

- 1 **[MENU]** (center of joystick) → **[#][5][0][0]**
- 2 **[▼]/[▲]**: "On" → **[SAVE]**
- 3 **[▼]/[▲]**: "Automatic" → **[SAVE]** → **[OFF]**

Base unit

Available for: KX-TGP550

- 1 **[MENU]** (middle soft key) → **[#][5][0][0]**
- 2 **[▼]/[▲]**: "On" → **[SAVE]**
- 3 **[▼]/[▲]**: "Automatic" → **[SAVE]** → **[EXIT]**

Static setup

Handset

Turning the DHCP connection mode off

- 1 **[MENU]** (center of joystick) → **[#][5][0][0]**

- 2 **[▼]/[▲]: “OFF” → [SAVE] → [OFF]**

Setting the static IP address and other settings

- 1 **[MENU]** (center of joystick) → **[≡][5][0][1]**
- 2 Set the IP address, subnet mask, default gateway, DNS1, and DNS2.
- Push the joystick down **[▼]** or up **[▲]** to move between the items.
 - To move the cursor, push the joystick right **[▶]** or left **[◀]**.
To correct digits, press **[CLEAR]**.
- 3 **[SAVE] → [OFF]**

Base unit

Available for: KX-TGP550

Turning the DHCP connection mode off

- 1 **[MENU]** (middle soft key) → **[≡][5][0][0]**
- 2 **[▼]/[▲]: “OFF” → [SAVE] → [EXIT]**

Setting the static IP address and other settings

- 1 **[MENU]** (middle soft key) → **[≡][5][0][1]**
- 2 Set the IP address, subnet mask, default gateway, DNS1, and DNS2.
- Press **[▼]** or **[▲]** to move between the items.
 - To move the cursor, press **[▶]** or **[◀]**.
To correct digits, press **[CLEAR]**.
- 3 **[SAVE] → [EXIT]**

FCC and other information

This equipment complies with Part 68 of the FCC rules and the requirements adopted by the ACTA. On the back/bottom of this equipment is a label that contains, among other information, a product identifier in the format US:ACJ-----.

If requested, this number must be provided to the telephone company.

- Registration No. (found on the bottom of the unit)

This equipment is hearing aid compatible as defined by the FCC in 47 CFR Section 68.316.

When you hold the phone to your ear, noise might be heard in your Hearing Aid. Some Hearing Aids are not adequately shielded from external RF (radio frequency) energy. If noise occurs, use an optional headset accessory or the speakerphone option (if applicable) when using this phone. Consult with your audiologist or Hearing Aid manufacturer about the availability of Hearing Aids which provide adequate shielding to RF energy commonly emitted by digital devices.

If the equipment is causing harm to the telephone network, the telephone company may request that you disconnect the equipment until the problem is resolved.

WHEN PROGRAMMING EMERGENCY NUMBERS AND/OR MAKING TEST CALLS TO EMERGENCY NUMBERS:

- 1) Remain on the line and briefly explain to the dispatcher the reason for the call.
- 2) Perform such activities in the off-peak hours, such as early morning or late evenings.

This device complies with Part 15 of the FCC Rules. Operation is subject to the following two conditions:

- (1) This device may not cause harmful interference, and (2) this device must accept

any interference received, including interference that may cause undesired operation.

Privacy of communications may not be ensured when using this phone.

CAUTION:

Any changes or modifications not expressly approved by the party responsible for compliance could void the user's authority to operate this device.

NOTE:

This equipment has been tested and found to comply with the limits for a Class B digital device, pursuant to Part 15 of the FCC Rules. These limits are designed to provide reasonable protection against harmful interference in a residential installation. This equipment generates, uses, and can radiate radio frequency energy and, if not installed and used in accordance with the instructions, may cause harmful interference to radio communications. However, there is no guarantee that interference will not occur in a particular installation. If this equipment does cause harmful interference to radio or television reception, which can be determined by turning the equipment off and on, the user is encouraged to try to correct the interference by one or more of the following measures:

- Reorient or relocate the receiving antenna.
- Increase the separation between the equipment and receiver.
- Connect the equipment into an outlet on a circuit different from that to which the receiver is connected.
- Consult the dealer or an experienced radio/TV technician for help.

FCC RF Exposure Warning:

- This product complies with FCC radiation exposure limits set forth for an uncontrolled environment.
- To comply with FCC RF exposure requirements, the base unit must be installed and operated 20 cm (8 inches) or more between the product and all person's body (excluding extremities of hands, wrist and feet).
- This product may not be collocated or operated in conjunction with any other antenna or transmitter.
- For body-worn operation, the handset must be used only with a non-metallic accessory. Use of other accessories may not ensure compliance with FCC RF exposure requirements.

Notice

- FCC ID can be found inside the battery compartment or on the back/bottom of the units.

FCC Declaration of Conformity

Trade Name: Panasonic

Model Number: KX-TGP550

Responsible Party: Panasonic Corporation
of North America
One Panasonic Way
Secaucus, NJ 07094
U.S.A.

Telephone No.: 1-800-211-PANA (7262)

Compliance with TIA-1083 standard:

Telephone handsets identified with this logo have reduced noise and interference when used with T-Coil equipped hearing aids and cochlear implants.



Industry Canada Notices and other information

NOTICE:

This equipment meets the applicable Industry Canada Terminal Equipment Technical Specifications. This is confirmed by the registration number. The abbreviation, "IC:", before the registration number signifies that registration was performed based on a Declaration of Conformity indicating that Industry Canada technical specifications were met. It does not imply that Industry Canada approved the equipment.

Users should ensure, for their own protection, that the electrical ground connections of the power utility, telephone lines and internal metallic water pipe system, if present, are connected together. This precaution may be particularly important in rural areas.

NOTICE:

Operation is subject to the following two conditions: (1) this device may not cause interference, and (2) this device must accept any interference, including interference that may cause undesired operation of the device.

Privacy of communications may not be ensured when using this telephone. Some cordless telephones operate at frequencies that may cause interference to nearby TVs and VCRs. To minimize or prevent such interference, the base of the cordless telephone should not be placed near, or on top of, a TV or VCR. If interference is experienced, move the cordless telephone further away from the TV or VCR. This will often reduce, or eliminate, interference.

RF Exposure Warning:

- This product complies with IC radiation exposure limits set forth for an uncontrolled environment.
- To comply with IC RF exposure requirements, the base unit must be installed and operated 20 cm (8 inches) or more between product and all person's body (excluding extremities of hands, wrist and feet).
- This product may not be collocated or operated in conjunction with any other antenna or transmitter.

- For body-worn operation, the handset must be used only with a non-metallic accessory. Use of other accessories may not ensure compliance with IC RF exposure requirements.

This telephone provides magnetic coupling for hearing aids.

Notes

For your future reference

We recommend keeping a record of the following information to assist with any repair under warranty.

Serial No.

Date of purchase

(found on the back/bottom of the base unit)

Name and address of dealer

Attach your purchase receipt here.